

planika

INSTALLATION AND USER'S MANUAL

Bino

G30/G31 (Propane-Butane/Propane)

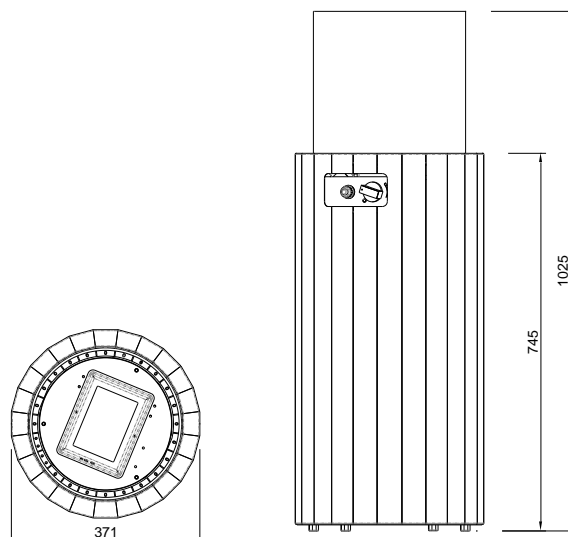
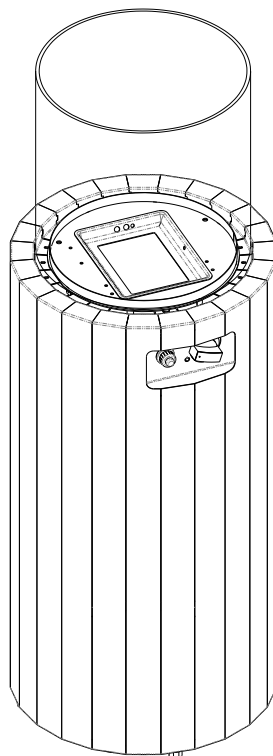

IT IS OBLIGATORY TO READ AND KEEP THIS INSTRUCTION MANUAL.

TABLE OF CONTENTS

| | |
|--|----|
| 1. INTRODUCTION | 3 |
| 2. SAFETY INSTRUCTIONS..... | 3 |
| 2.1 Safety instruction regarding the use of the gas cylinders..... | 4 |
| 3. INSTALLATION | 4 |
| 3.1. Box contents | 4 |
| 3.2. Unboxing and installation | 4 |
| 3.3. Gas cylinder replacement | 7 |
| 3.4. Regulator replacement | 10 |
| 4. OPERATING INSTRUCTIONS | 11 |
| 4.1. General Notes | 11 |
| 4.2 Start-up of the device | 11 |
| 4.3 Regulation of the flame size..... | 12 |
| 4.4 Device shutdown..... | 12 |
| 5. TESTING..... | 13 |
| 5.1 Checking for gas leaks | 13 |
| 5.2 Checking the flame appearance..... | 13 |
| 6. MAINTENANCE AND UPKEEP | 14 |
| 6.1. Testing and cleaning | 14 |
| 7. WARRANTY..... | 14 |
| 8. TROUBLESHOOTING..... | 15 |
| 9. MANUFACTURER’S CONTACT DETAILS | 15 |
| 10. TECHNICAL SPECIFICATION | 15 |

1. INTRODUCTION

The Bino fireplace is a decorative fuel-effect gas appliances destined only for outdoor use. It is obligatory to acquaint oneself with the below installation manual and user's manual before committing to the installation and use of The Bino fireplace. This manual is to be kept safe for the lifetime of the device.

WARNING! The device must be installed by the installer who is certified and qualified specialist in gas heating and should have all the qualifications required by local law. Failing to comply with the above condition may result in voiding the warranty.

2. SAFETY INSTRUCTIONS

- Read the instructions before using the appliance.
- Use outdoors only.
- The Bino fireplace should be installed and controlled annually according to the below installation manual as well as enforced national and local laws regarding gas safety (installation and use).
- One needs to assess whether the data on the product plaque complies with the local type of gas and pressure.
- Do not change the structure of the device or its sealed elements nor modify the default settings of The Bino fireplace.
- Do not set any additional imitation blocks nor any glowing coal fragments on the burner or in the combustion chamber. Only use manufacturer-approved decorative accessories for Planika fireplaces
- A CO2 or a powder fire extinguisher needs to be placed near the device.
- During the first ignition The Bino fireplace needs to be burnt on maximum level for a few hours in order for the elements to acquire correct temperature and for the remains of paint, lacquer and lubricant to evaporate.
- Do not move the device while it's working.
- Bino has been designed for decorative purposes. Surface of The Bino may get hot (up to 100 degrees Celsius) with the exception of the side walls of the appliance as well as the control panel. **WARNING!!!** Parts of the device that are easy to reach may be very hot. Keep children away from the device.
- This appliance must be kept away from flammable materials during use. Do not place any combustible materials within a distance of 1 m of Bino and 1 m over the appliance (Fig. 1).

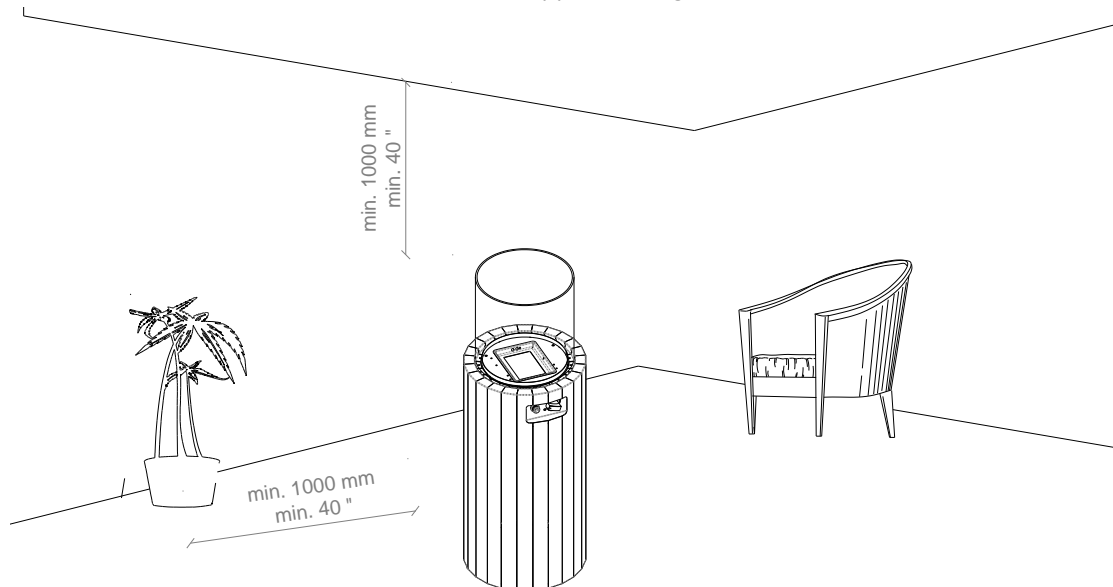

Fig. 1: Minimum distance to flammable materials

- An amply ventilated area must have a minimum of 25 % of the surface area open. The surface area is the sum of the walls surface.
- When The Bino fireplace is on it's not to be exposed to rain.
- When not being used The Bino is to be protected from atmospheric conditions and the main valve of the gas cylinder needs to be turned off.
- If The Bino is not in use for a longer period of time (e.g. winter time), we advise you to store it inside.

- The Bino fireplace's parts are made of stain resistant material.
- Never leave a turned on Bino without supervision.
- The Bino fireplace needs to be installed in a place inaccessible for children, unauthorised persons or animals for the direct contact with the flame or hot parts of the device to be impossible.
- In case of heavy wind The Bino fireplace needs to be immediately turned off and one needs to wait until the heavy wind passes.
- In case of noticing any sort of gas leaks the fireplace as well as the main valve of the gas cylinder need to be turned off.
- After use turn off the gas cylinder valve.
- Salty seawater environment accelerates the corrosion process and contributes to fireplace damage

2.1 Safety instruction regarding the use of the gas cylinders.

- Use only the type of gas and pressure specified by the manufacturer.
- The gas cylinder should always be placed in a vertical position – during use and transport.
- Always store the gas cylinder in an easily accessible place to allow its immediate turn-off.
- During the installation process do not allow an open flame or any ignited object to reach the gas cylinder.
- Leaks should be found with the use of a cleaning liquid and water. If bubbles form on the surface that means that a there's an existing leak.
- Always use a pressure regulator between the gas cylinder and the device. Replace the pressure regulator every 5 years. The allowed pressures are: 30mbar, 37mbar (recommended), 50 mbar. Use only regulators complying with the European EN16129 Norm.
- Use only approved and certified gas connection linkage. Replace the linkage every 2 years.
- The elastic linkage connecting gas to the fireplace is to be led away from sharp edges and hot surfaces. Refrain from bends and twists of the elastic connection on its full length.
- The gas cylinder needs to be shut if the fireplace is not being used.
- Filling the gas cylinders is to be commissioned to certified gas filling stations.
- Replacement of empty cylinders for full ones is to be conducted only in authorised locations

3. INSTALLATION

3.1. Box contents

- 1x complete Bino gas fireplace
- 1x AAA Batteries
- 2x bags of decorative stones
- 1x glass tube
- 1x round foam
- 1x wrench
- 1x 1,4 metre rubber gas linkage – installed
- 1x pressure regulator (37mbar)
- 1x installation manual and user's manual

3.2. Unboxing and installation

- The contents of the boxes need to be carefully unwrapped from the foam foil.
- Remove the bags with decorative stones from the burner reservoir and place them away from it.
- Remove the styrofoam placed on the unit.
- Cut the transportation clamps holding the unit and place them away.
- Check the completeness of the elements with the contents list.
- Make sure that the device nor its elements weren't damaged during the transportation (if they were, notify the supplier).

- Place the fireplace on side and unassemble the stands holding the transportation frame for glass tube. Put the glass tube aside as well as round foam and stands for future use.

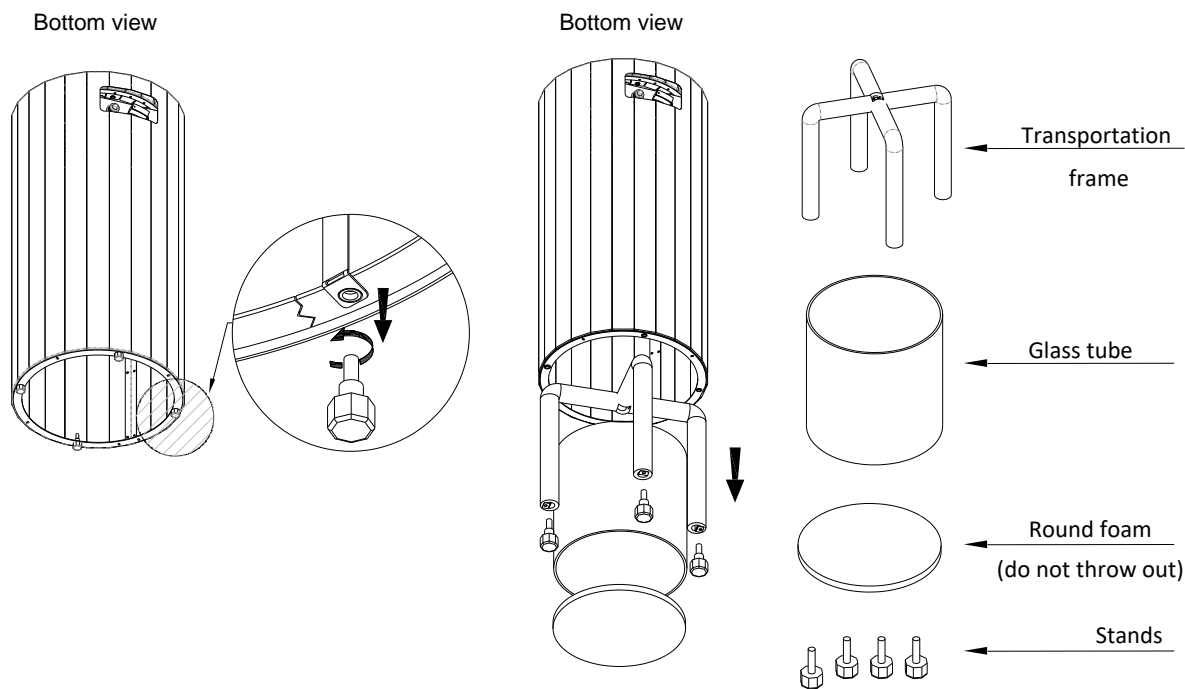

Fig. 2 – Unassembling transportation frame

- Assemble the stands in pre made holes screwing them in.

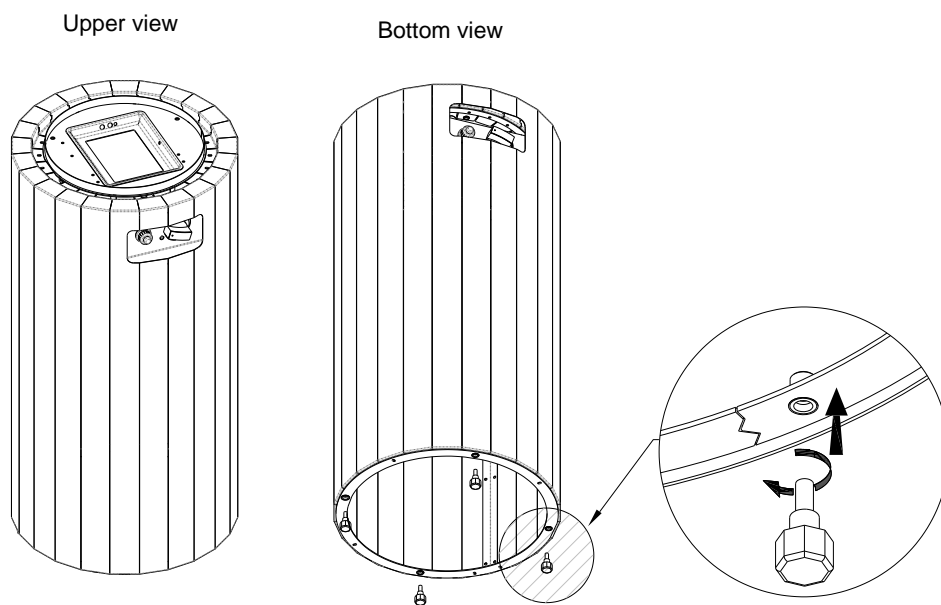
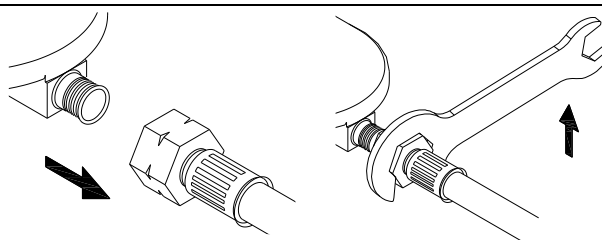

Fig. 3 – Assembling the stands

- Connect the gas cylinder to the pressure reducer according to the scheme

THREAD CONNECTOR

If your gas pressure reducer is equipped with thread connector screw it on using HEX spanner wrench included to the product turning it counterclockwise.

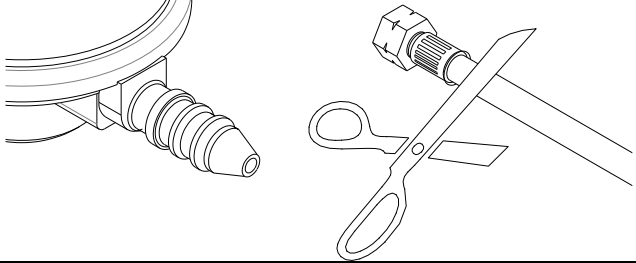
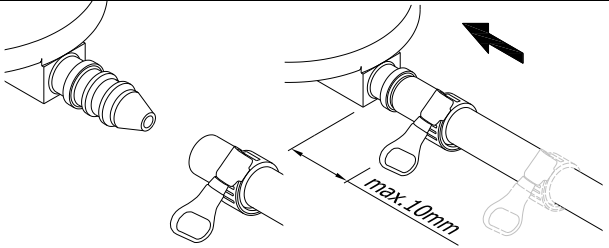
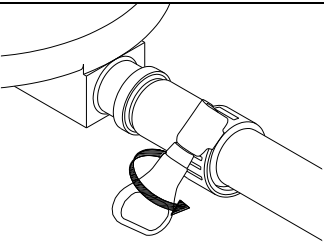

BARB CONNECTOR

| | |
|---|--|
| <p>If your gas pressure reducer is equipped with hose barb connector. Cut off the end of the gas hose with screw ending.</p> |  |
| <p>Move the clamp into the stub and assemble the pressure reducer. Make sure the clamp will not be further than 10mm from reducer.</p> |  |
| <p>Tighten the clamp by turning it clockwise.</p> <p>WARNING! In the event of visible damage on the clamp, replace it for a new one.</p> |  |
| <p>Warning. To make it easier to apply the gas hose to the regulator outlet, you can heat the 2 cm hose end under warm water.</p> <p>Warning. A wrench is single-use tool.</p> <p>Warning. Check the sealness after assembling the reducer using soapy water (If air-bubbles are present that means the connection has a leak)</p> | |

- Place the fireplace in a way that it will cover the gas cylinder after connecting the pressure reducer. Make sure you will place the gas cylinder on round foam.
- Put the glass tube on.

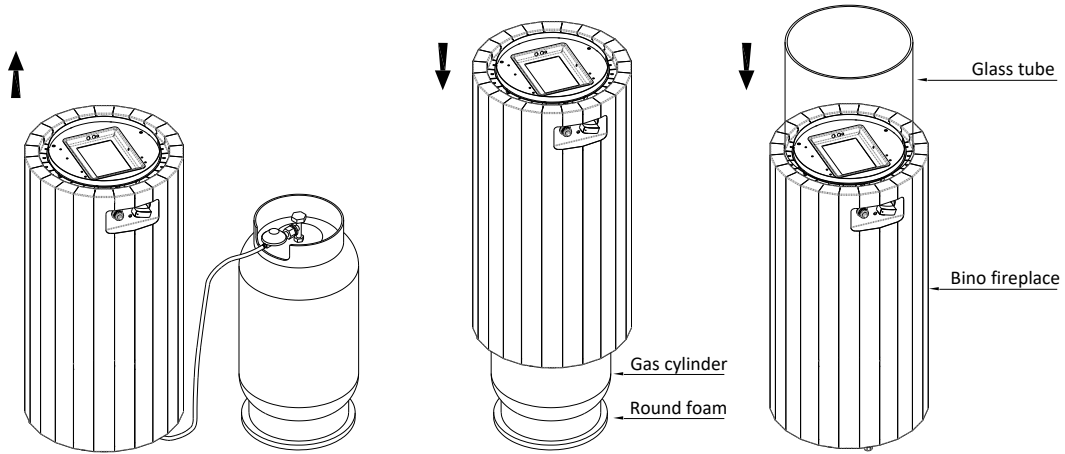

Fig. 4 – Locating the fireplace in right way

- The decorative stones are to be scattered evenly around the reservoir to completely cover the burner of the fireplace.



Fig. 5 – Bino top view with ignition elements detail

3.3. Gas cylinder replacement

WARNING!!! The montage and service needs to be conducted by a qualified professional, a company or the gas supplier.

Before proceeding with the connection of the gas cylinder to the fireplace all activity regarding the correct placement and installation of the BINO needs to be already performed. Take off the glass tube and decorative elements from the burner, uncover the gas cylinder by lifting the fireplace up and placing it aside. Place the gas linkage away from hot or sharp edges and make sure it is not twisted.

The BINO is delivered together with an elastic gas linkage which, on one end is connected to the valve of the device and one the other end to the gas regulator ready to be connected to the gas cylinder.

| Pressure reducer type | Country | Connection Type | Connection Type | Inlet Diameter | Outlet |
|-----------------------|---|-----------------|-----------------|----------------|----------|
| Type A | FR, UK, IE, MA | Clip On | G59/H4 | 27 mm | G1/4"-LH |
| Type B | ES, DK, NO, FI, EE, PT, CY | Clip On | | 35 mm | G1/4"-LH |
| Type C | PL, DE, LT, AL, BE, CZ, SK, SI, LV, HR, UA, RS, MK, BiH | Twist On | G12/H4 | 21,8 mm | G1/4"-LH |
| Type D | IT, GR | Twist On | G1/H4 | 20 mm | G1/4"-LH |

If your gas cylinder has a different inlet size or requires a different regulator, replace the included regulator with the required one (available separately at your local market)

One needs to control the expiry date both of the regulator as well as the gas linkage and if necessary (for instance: broken, cut, scratched linkage) replace the components for new ones according to national standards and norms.



The BINO fireplace can use metal or steel bottles or composite bottles filled with propane-butane gas or propane gas.

WARNING!!! NEVER use an unstable gas connection (without a regulator).

Gas cylinders have two types of connectors:

- Twist-on connection: The most important thing is the black seal. Always check if the seal is present and whether it hasn't been damaged during the gas cylinder replacement. Some connections have a knob to fasten them in place while others require the use of a wrench. Tighten securely (left thread). Using the tool pay attention not to fasten the connection too tightly as this may damage the seal.
- Quick-release: For this type of connection no tool is required. On/off regulation of gas connection is made through a switch on the regulator or on a special connector. In case of using a connector with a thread regulator of an old type put a special emphasis on checking if the connecting nut has been tightly fastened with the help of wrench.

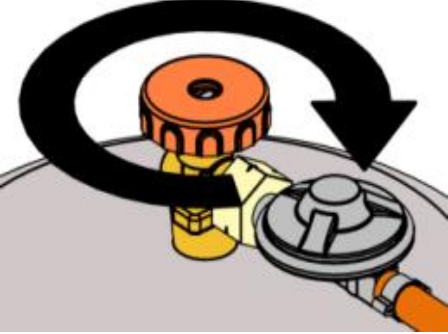
Disconnection of the gas cylinder

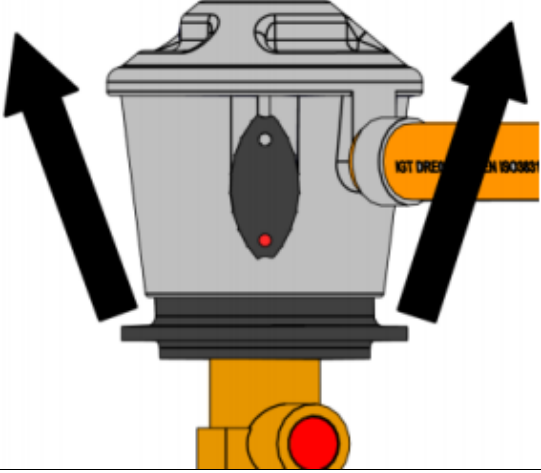
| Twist-on connection | Quick-release |
|--|--|
| <p>1. Turn off the BINO – put it into the OFF position. The main burner need to be turned off.</p> <p>2. Turn the bottle valve into the OFF position (clockwise).</p>  | <p>2. Turn the switch into the OFF position.</p>  |
| <p>3. DO NOT unmount the regulator (or connecting nut) when the bottle valve is open.</p> <p>4. TAKE OFF the regulator (or the connecting nut) with the use of a wrench or a connecting knob.</p>  | <p>3. Take off the quick-release regulator by pressing the switch horizontally and simultaneously pulling the whole regulator upwards.</p>  |
| <p>5. REPLACE the linkage closer or cap on the empty or partially full bottle if it's not being used.</p> | <p>4. REPLACE the tightening cap on an empty or partially full bottle if it's not being used.</p> |

Gas cylinder connection

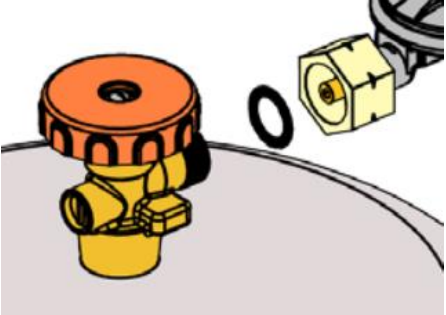
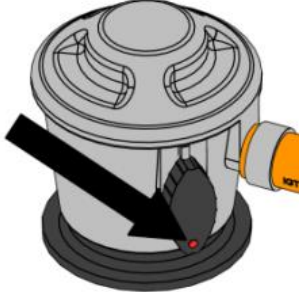
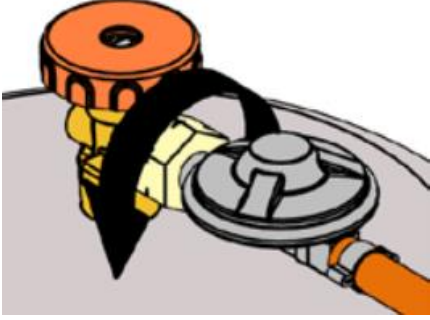
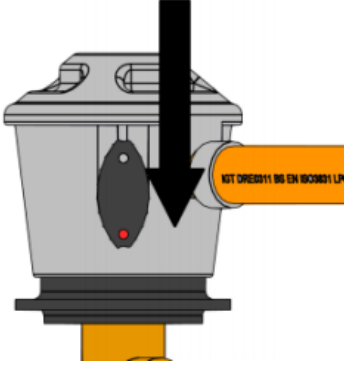
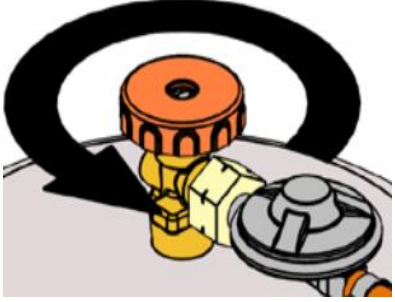
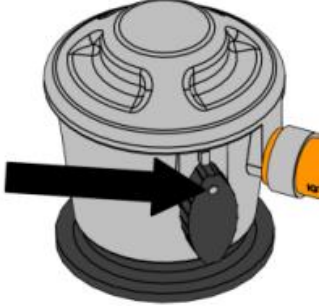
| Twist-on connection | Quick-release |
|--|---|
| <ol style="list-style-type: none"> 1. Check if the bottle valve is TURNED OFF turning it clockwise 2. Remove the protection tip and store it for later use. | <ol style="list-style-type: none"> 1. Remove the protection tip. Do not use any tools, leave the tip hanging freely. |
| <ol style="list-style-type: none"> 3. Before making the connection check if the black seal is not damaged.  | <ol style="list-style-type: none"> 2. Make sure all the taps on the gas device are closed and if the switch is in the OFF position.  |
| <ol style="list-style-type: none"> 4. Fit the connecting nut to the cylinder with the use of a correct wrench or the connecting knob. (left thread) Do not allow the gas bottle connectors to be fastened too tightly.  | <ol style="list-style-type: none"> 3. Place the quick-release regulator on the valve and press it down hard. If the switch is correctly turned off you will hear a characteristic click.  |
| <ol style="list-style-type: none"> 5. When the gas flow is required turn the valve of the bottle counter-clockwise.  | <ol style="list-style-type: none"> 4. To let the gas flow in turn the switch into the ON position (or into the flame image).  |

WARNING!!! Check the gas connection for leakage. If anything suggests a leak is present (for instance a characteristic gas smell) close the gas bottle valve and under no circumstances turn the device on before removing the leak.

- After removing the leak one may open the gas bottle valve again.

3.4. Regulator replacement

1. You always need to use a pressure regulator between the gas bottle and the device. Replace the pressure regulator every 5 years. Allowed pressures: 30 mbar, 37 mbar (recommended), 50 mbar. Use only the regulators that comply with the EN16129 European Norm.
2. Turn off The BINO– the „OFF” position. The main burner need to be turned off.
3. Disconnect the regulator from the gas bottle (description above).

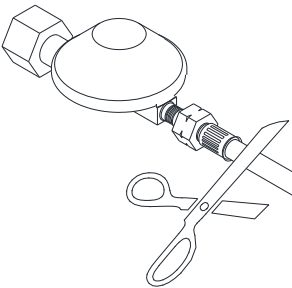
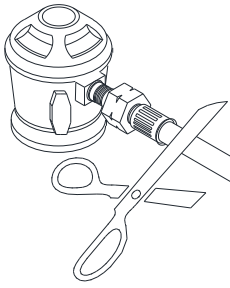
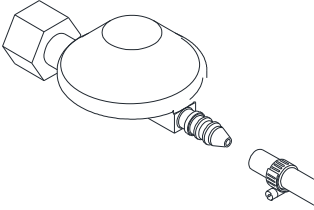
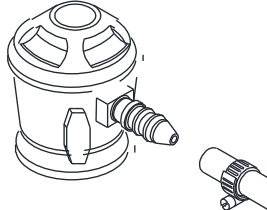
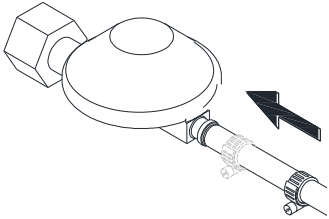
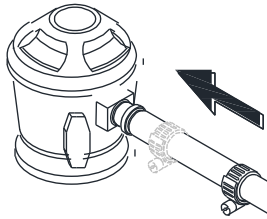
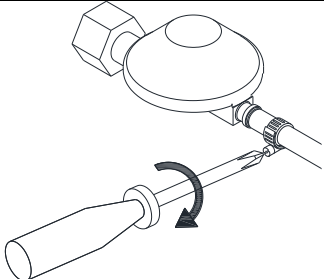
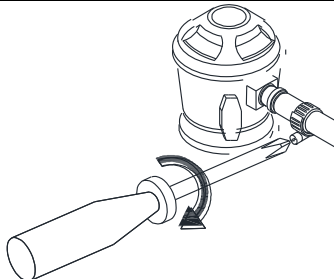
| | Twist-on connection | Quick-release |
|---|---|---|
| 4. Cut off attached pressure reducer or go to step 4.1. if you have pressure reducer with clamp connection. |  |  |
| 5. Replace the regulator to new one with clamp connection by attaching new linkage on the stub of regulator. |  |  |
| 6. Move the clamp into the stub |  |  |
| 7. Tighten the clamp with screwdriver (philips) or a flat wrench. WARNING! In the event of visible damage on the clamp, replace it for a new one. |  |  |

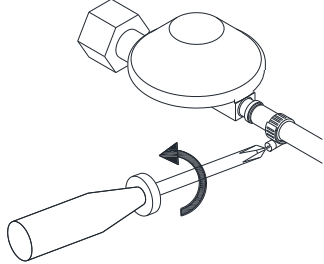
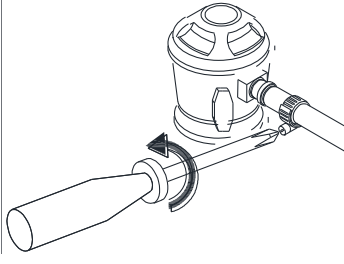
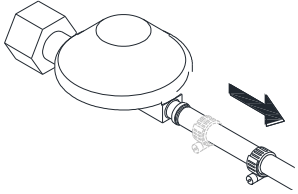
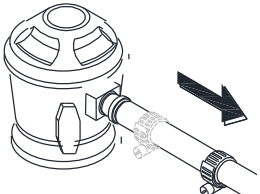
| | Twist-on connection | Quick-release |
|---|---|---|
| a. Loosen the metal clamp with the use of a screwdriver (philips) or a flat wrench. |  |  |
| a. Move the clamp away from the stub of gas regulator and go to step 5 |  |  |

- BINO is equipped with the anti-tilt valve which shuts the device down in case if the fireplace is tilted or collapsed. The valve automatically cuts off the gas supply to the controller and this extinguishes the flame.

WARNING!!! make sure the anti-tilt valve is always installed in upward position.



Fig 6– Anti -tilt sensor

4. OPERATING INSTRUCTIONS

4.1. General Notes

The Bino fireplace has a control valve with a built-in ignition for the main burner (without pilot flame). The flame height of the main burner may be appropriately regulated by turning the knob. Next to the knob is placed elective ignition button (powered by AAA battery). The control panel is placed on side of the fireplace.

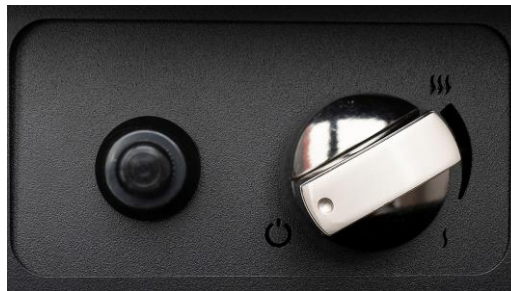

Fig. 7– Control knob and ignition button

4.2 Start-up of the device

- Make sure that the knob is placed in „OFF” position (all the way clockwise).



Fig. 8– Off position

- Open the valve on gas reducer
- Press the knob and while still pressing turn it counter-clockwise from position (1) to position (2)



Fig. 9– Turning the device on

- While keeping the knob still pressed start the flame by pressing the ignition button (3).



Fig. 10– Ignition sequence

- A spark will appear which ignites the main burner on the minimum flame height. If the flame did not ignite repeat this process 2-3 times. This will be required especially when you have replaced and installed a new LPG gas cylinder.
- When the flame is ignited keep holding the knob for around 5 seconds until the thermo-couple, which will keep the main valve in an open position, warms up.
- You may now release the knob. If however the flame is extinguished repeat the process once again until a stable flame is achieved.

WARNING!!! After 2-3 unsuccessful attempts terminate and check the connections. Try again in 10 minutes. If the installed gas cylinder is new or the fireplace has not been used for a longer period, the first thing that needs to be done is to release air from the gas linkage. In this case conducting a few attempts will be needed until the flame is ignited.

4.3 Regulation of the flame size

- When the flame is burning the desired height of the flame may be adjusted and regulated by turning the knob clockwise or counter-clockwise.
- To achieve a higher flame turn the knob clockwise to “Hi” position. To achieve a lower flame turn the knob counter-clockwise to “Lo” position (*Fig. 12*).



Fig. 11– Flame regulation

4.4 Device shutdown

- To turn off the device, simultaneously press and turn the knob all the way clockwise. The gas supply will be cut and the flame on burner will be turned off.

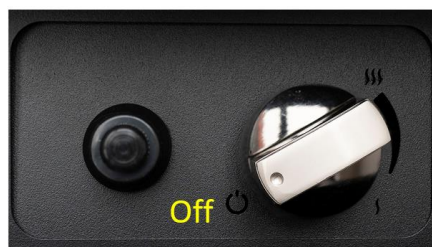

Fig. 12 – Turning the device off

- Additionally, close also the valve on the gas reducer.

4.5 Replacing the battery

If the battery is inserted incorrectly, the electronic ignitor may be irreparably damaged. Only replace the battery when the appliance has been completely switched off.

The battery is placed in the container located on the control pane next to the flame regulation knob

- Unscrew the ignition button
- Remove the battery and place the new one into the slot.

WARNING! Remember about proper polarization of the battery.

- Screw the cover of the battery container.

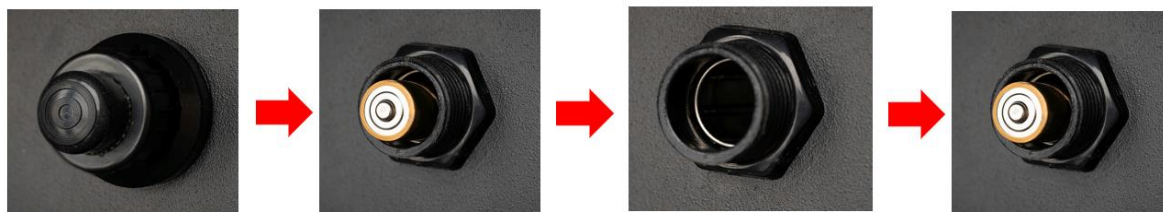

Fig. 13 – Replacing batteries

5. TESTING

WARNING!!! NEVER TURN ON THE DEVICE IF THE CHARACTERISTIC SMELL OF GAS IS PERCEPTIBLE.

If you smell gas during the operation of the fireplace turn off the device immediately and cut off the gas supply from the gas cylinder by shutting its valve.

5.1 Checking for gas leaks.

- Check if all connections are airtight.
- To do that apply all connections with soapy water (or water with another foamy substance) or with a professional spray for leak detection.
- If air-bubbles are present that means the connection has a leak.
- Remove the leaks in the identified spaces.
- Check for leaks once again.
- After the inspection dry the inspected connections.
- The device may only be used again after all leaks are removed.
- **If the problem happens again please contact the dealer.**

5.2 Checking the flame appearance.

- Burn The Bino on max flame height and check the appearance of the flame.
- If visible gaps are present or there are substantial differences in flame height turn off the fireplace and after the device is cooled adjust the placement of decorative stones in such a way for them to be evenly placed on the whole surface of the main burner.
- Turn on the fireplace and check the appearance of the flame once again.

6. MAINTENANCE AND UPKEEP

6.1. Testing and cleaning

Please check and clean if necessary:

- The main burner - if necessary, remove broken parts of stones and the existing dust.
- Thermo-couple (if necessary, remove the existing sediment). In the event of visible damage contact your dealer.
- Gas linkage and pressure regulator (in case their expiry date is invalid replace these ancillaries for new ones).
- If you encountered problems with the regulator, gas linkage, burner or regulation valves do not try to fix these parts. Contact a sales person, an authorised service or an importer in order to acquire spare parts. To ensure the device is working efficiently use only original spare parts.

7. WARRANTY

Planika Sp. z o.o. grants the Client guarantee of quality for the smooth operation of the goods specified on the sales document. The warranty is determined for a given period from the date of purchase (based on the warranty card together with the receipt of purchase). The warranty period starts at the moment of purchase of the original product by the first end user. Product may consist of several separate parts and different parts may be covered by a different warranty periods. The manufacturer gives 2 year warranty from date of purchase an insert for its smooth operation. Fireplace sealing is covered by warranty for a period of 1 year from date of purchase of the device. Guarantee does not cover decorative ceramic logs/stones and glass elements (glass shield and glass top). The use of the fireplace insert and operating conditions must be in accordance with the user manual and with the regulations in force. The basis for the free repair covered by warranty is a warranty card. Warranty Card will expire without a date, stamps, signatures, as well as the amendments made by unauthorized persons. Customer entitlement under the guarantee will expire automatically: after the warranty period. Any damages caused by improper handling, storage, of poor maintenance, incompatible with the conditions laid down in the manual and due to other reasons not due to the fault of the manufacturer, will void the warranty. In the event of a complaint, always contact your dealer. Supplier will contact the company Planika, if it deems it necessary. Factory Warranty is valid for 2 years from the date of purchase. Details of the warranty are available on the <https://www.planikafires.com/warranty-cards/>

8. TROUBLESHOOTING

Warning! Montage, upkeep and service need to be conducted by a qualified professional with appropriate qualification, an appropriate company or the gas supplier.

| PROBLEM | POSSIBLE CAUSE | CORRECTIVE ACTION |
|---|---|---|
| SMELL OF GAS | CLOSE THE VALVE ON THE GAS CYLINDER IMMEDIATELY. DO NOT USE THE DEVICE UNTIL LEAKS HAVE BEEN REMOVED. | |
| Leak detected at cylinder, regulator or other connection. | <ol style="list-style-type: none"> 1. A loose regulator linkage. 2. Leak in the gas linkage, in the regulator or on the gas knobs. | <ol style="list-style-type: none"> 1. Tighten and test it. 2. Report this issue to service. |
| Burner does not ignite | <ol style="list-style-type: none"> 1. The cylinder is empty. 2. Igniter linkage is not connected. 3. No ignition spark. 4. The igniter electrode is placed incorrectly opposite the igniter. 5. Gas nozzles are blocked. 6. Gas linkage is twisted. 7. Pressure regulator link is loose. | <ol style="list-style-type: none"> 1. Replace Gas cylinder. 2. Connect the igniter linkage. 3. Replace igniter. 4. Realign electrode and clear any surrounding debris from area. 5. Unmount burner, clean the nozzle. 6. Straighten the linkage. Keep the linkage away from the housing. 7. Tighten the link. Check for leaks. |
| Igniter Not Working | <ol style="list-style-type: none"> 1. Ignitor wire not connected. 2. Electrode misaligned on pilot burner 3. Igniter malfunction 4. The battery has run out | <ol style="list-style-type: none"> 1. Ensure pilot electrode wire is connected. 2. Realign electrode and clear any surrounding debris from area. 3. Replace Igniter 4. Replace battery |
| Low efficiency, „cracking” sounds | <ol style="list-style-type: none"> 1. The cylinder is empty. 2. The nozzles of the burner are blocked. | <ol style="list-style-type: none"> 1. Replace Gas cylinder. 2. Unmount the burner, clean the nozzle. |
| Thumping sounds made by the regulator. | The gas valve has opened rapidly. | Unfasten the regulator valve slowly. |
| A vivid/ bright orange and smoky flame of the burner. | Holes blocked in the apparatus producing the gas and air mixture. | Unmount the burner and clean/ unblock the apparatus' holes. |

9. MANUFACTURER'S CONTACT DETAILS

Company Name: Planika Sp. z o.o.
Address: Bydgoskich Przemysłowców 10
Telephone: + 48 52 364 11 60

10. TECHNICAL SPECIFICATION

| Appliance Category | I3P | | | I3B/P | | | I3+ | | |
|-------------------------|--------------|-----|------|-------|-----|------|-----|-------|------|
| | | G31 | | G30 | | G30 | G31 | | |
| Reference gas | | G31 | | G30 | | G30 | G31 | | |
| Inlet pressure | [mbar] | 30 | 37 | 50 | 30 | 37 | 50 | 28-30 | 37 |
| Injector diameter | [mm] | 1,2 | | | 1,2 | | | 1,2 | |
| Gas consumption | [kg/h] | 0,4 | 0,45 | 0,5 | 0,4 | 0,45 | 0,5 | 0,4 | 0,45 |
| Nominal Heat Input (Hi) | [kW] | 4,5 | 5,0 | 6,4 | 5,1 | 6,4 | 7,4 | 5,1 | 5,1 |
| Nominal Heat Input (Hs) | [kW] | 5,0 | 5,5 | 7 | 5,6 | 7 | 8 | 5,6 | 5,6 |
| Safety device | Thermocouple | | | | | | | | |
| Gas control valve | BS190 | | | | | | | | |
| Flexible hose (1,4 m) | Ø9mm | | | | | | | | |

| SELLER | |
|--|-----------------------------|
| Name: | Seller's seal and signature |
| Address: | |
| Tel/fax: | |
| Date of sale: | |
| BUYER | |
| Name: | |
| Address: | |
| Tel/fax: | |
| Date of purchase: | |
| <p>The gas fireplace should be installed by a qualified Installer in accordance with the applicable national building regulations and in accordance with the guidelines contained in the Installation and User's Manuals.</p> | |
| <p>I hereby declare that having read the User's Manual and the Guarantee Conditions.</p> | |
| <p>Date and legible signature of the Buyer</p> | |
| INSTALLER | |
| Name: | |
| Address: | |
| Tel/fax: | |
| Date of commissioning: | |
| <p>I hereby declare that the gas fireplace installed by my Company has been installed in accordance with the applicable building regulations and in accordance with the guidelines contained in the Installation and User's Manuals.</p> <p>The installed gas fireplace is ready for safe operation.</p> | |
| <p>Installer's seal and signature</p> | |